

WATERPROOF SYSTEM



Window Wall is the first waterproof Shopfront system in South Africa. It is quick and easy to install and a pneumatic punching tool makes fabrication quicker too.

HBS
ALUMINIUM SYSTEMS



Window Wall

- for the Architect

WATERPROOF SHOPFRONT SYSTEM

- A3 performance rating (SANS 613:2011)
- Water and weather-proof, structurally sound.
- Domestic or commercial applications, coastal or inland locations.
- 40mm standard frame width.
- 75mm split mullion frame width.
- Up to 5400mm height screens.
- Hinged single/double doors, sliding, folding doors, and project out sash inserts.

Typical Split mullions

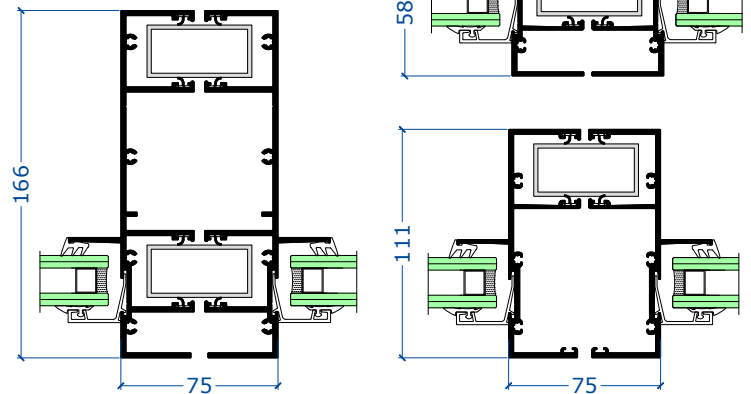

GLASS & GLAZING

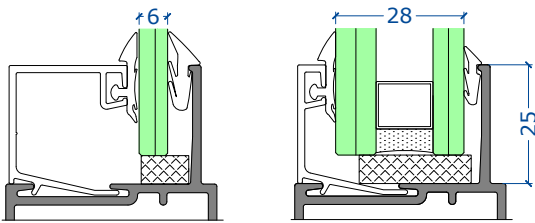

- 6-28mm single or double bead glazing.
- U-value down to 3.36 with 24mm Low E glass.
- 25mm high glazing rebate provides full cover of the SIG glazing spacer.

WW SASH - MP LOCKING

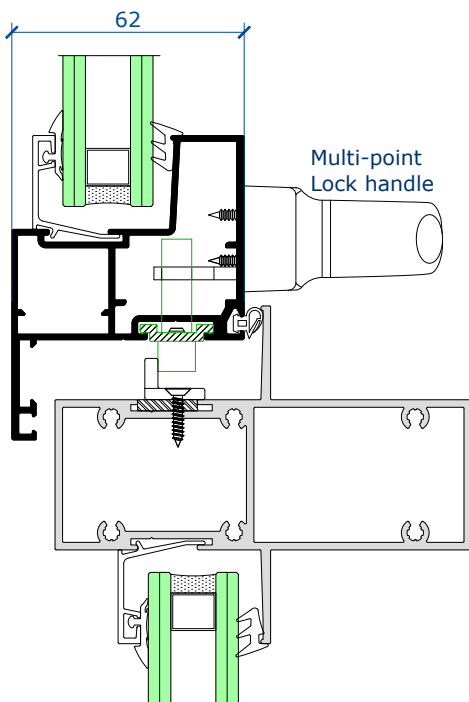

- Max. sash size:
 - 1700x1600mm (WxH) Top Hung.
 - 1000x1700mm (WxH) Side Hung.
 (depending on stays)
- Max. sash weight 75kg

FRAME CONSTRUCTION OPTIONS

- **Flat screens**
Optional Compensation & Split Mullions



- **Curved, segmented screens**
(Split Mullions, Max 6-8° per mullion)

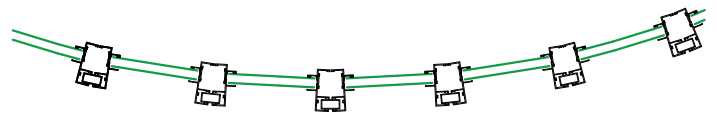

FRAME INSERTS - DOORS & WINDOWS

- **Native sash & door inserts**

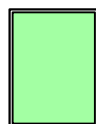

Fixed

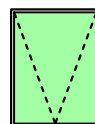

Top Hung

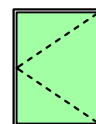

Side Hung

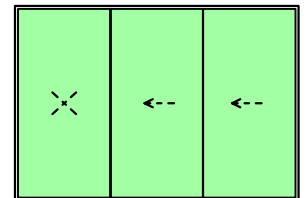

Galaxy Sliders (A2)

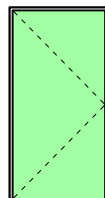

Single Door

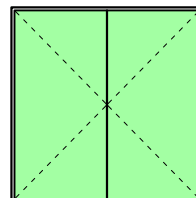

Double Door

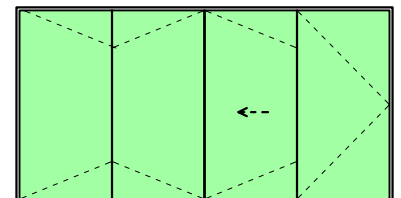

FoldAway, Vista Fold Door



Window Wall

- for the Fabricator

OPTIMUM PRODUCTIVITY

- Pneumatic punching for superior fit & finish.
- On-site or in factory fabrication with split mullion assemblies ranging from 58, 111, 166mm in size.
- Optional floating head, sill and side compensation.
- Optimised cost of assembly, product quality & time.

PANEL ASSEMBLY

- Quick and efficient panel construction using split mullions - left and right, installed internally or externally into compensated frame.
- For multi-storey installations with minimum scaffolding costs.

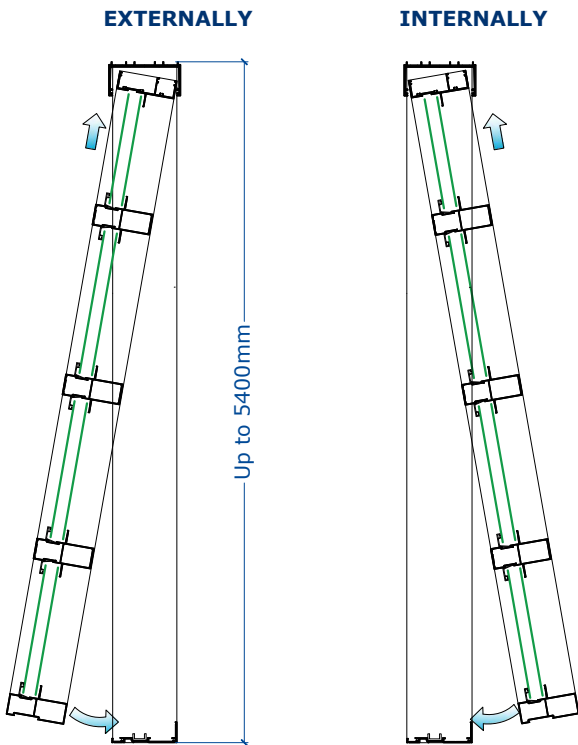

SPLIT MULLION - PANEL INSTALLATION

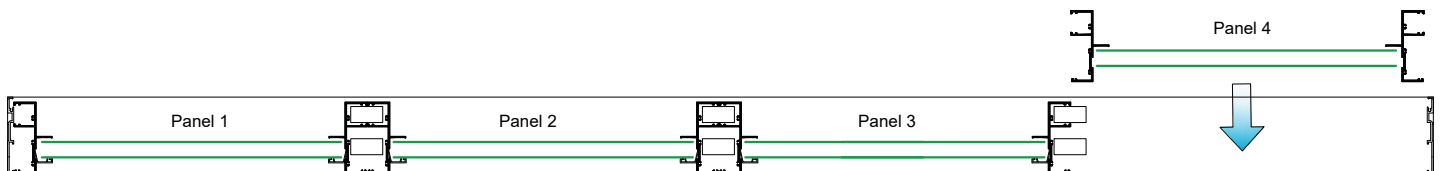

**Accredited Laboratory
Test Certificate**

SANS 613:2011

THIS CERTIFICATE RECORDS THE SUCCESSFUL TESTING OF THE TEST SAMPLE INDICATED BELOW IN ACCORDANCE WITH SOUTH AFRICAN FENESTRATION PRODUCT STANDARD SANS613:2011 excl. par. 5.7

| | |
|-----------------------------|---|
| | DATE OF ISSUE: 15/05/2012 |
| A3 PERFORMANCE CLASS | MANUFACTURER: HBS ALUMINIUM SYSTEMS |
| | TEST SAMPLE: WINDOW WALL CASEMENT |
| | SYSTEM SUPPLIER: HBS ALUMINIUM SYSTEMS |
| | TEST NUMBER: PCR 083 |
| | WATER PRESSURE: 400 (PA) |
| | DEFLECTION PRESSURE: 2000 (PA) |
| | STRUCTURAL PRESSURE: 3000 (PA) |
| | AIR INFILTRATION: 0.30 (L/sec/m²) |

TEST SAMPLE DETAILS:

DESCRIPTION: WINDOW WALL

DRAWING NAME: HBS18-06

NO. OF PAGES: N/A

PROFILES USED ON TEST SAMPLE (CODE & DESCRIPTION):

FRAME: AB217, AB208

TRANSOM: AR205

MULLION: AB212

SPLIT MULLION: AB205, AR300

SASH: AB227 Eq.

MULTI-POINT LOCK SYSTEM

GLASS USED ON TEST SAMPLE (DESCRIPTION & THICKNESS):

GLASS TYPE 1: 6.38mm LAMINATED CLEAR

GLASS TYPE 2: N/A

PANELS USED: N/A

GASKETS & BEADS USED ON TEST SAMPLE:

GASKET 1: HK512 BUTTERFLY

GASKET 2: HK513 WEDGE

TEST SAMPLE ELEVATION:

PRECISION FABRICATION

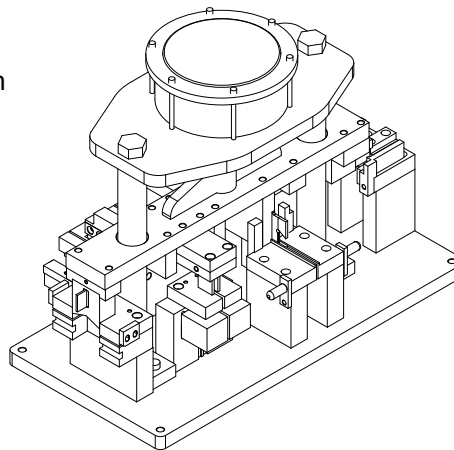

ACCURATE RESULTS

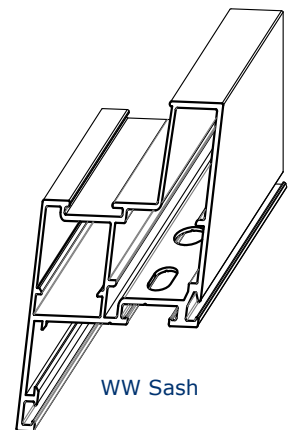

- Easy, quick machining.
- Increased productivity.
- Cost-effective.
- Reduces wastage and incorrect machining.

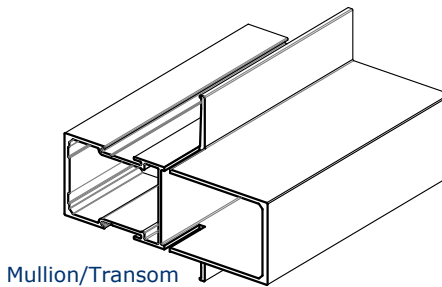

Mullion/Transom

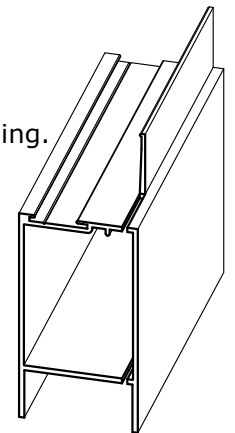

Top/bottom Rail

REASONS WHY ARCHITECTS, FABRICATORS AND HOME OWNERS LOVE WINDOW WALL

1. TESTED TO THE LIMIT

Compliance to SANS613 A3 performance class allows it to be specified and installed in South Africa and regionally. Every system from HBS is tested to its limits for your peace of mind.

2. THE ONLY WATERPROOFED SHOPFRONT SYSTEM

On account of excellent weather and water performance, Window Wall is applicable in inland or coastal conditions.

3. SIMPLE AND DURABLE PRODUCTS

Our sections allow for effortless and long lasting products, ranging from high facades, various door and window types, superior to competing products.

4. QUICKER FABRICATION & FLEXIBLE INSTALLATION

Quality assured precision punching, makes machining and fabrication up to 10 times faster, and more cost effective. Easy internal or external panel installation.

5. LOCALLY STOCKED & SUPPORTED

All Window Wall profiles and hardware are available off the shelf, so no extended lead times. Place the order, choose the colour and you will be fabricating and installing in no time.



ALUMINIUM SYSTEMS

www.hbs.co.za

JHB 011 626 3330

CT 021 534 7420

2025